

HEIDENHAIN

Montageanleitung

Mounting Instructions

Instructions de montage

Istruzioni di montaggio

Instrucciones de montaje

取付説明書

安装说明

安裝指導手冊

설치 지침

SE 640

9/2012

Inhalt
Contents
Sommaire
Índice
Índice

Seite
4 Warnhinweise
8 Abmessungen
10 Montagezubehör
12 Spannungsversorgung
14 Signalübertragung
16 Zustand des Tastsystem
20 Anschlussbelegung
22 Technische Kennwerte

Page
4 Warnings
8 Dimensions
10 Mounting accessories
12 Power supply
14 Signal transmission
16 Status of the touch probe
20 Pin Layout
22 Specifications

Page
4 Avertissement
8 Dimensions
10 Accessoire de montage
12 Tension d'alimentation
14 Transmission du signal
16 Etat du palpeur
20 Raccordements
22 Caractéristiques techniques

Pagina
4 Avvertenze
8 Dimensioni
10 Accessori di montaggio
12 Tensione di alimentazione
14 Trasmissione del segnale
16 Stato del sistema di tastatura
20 Piedinatura
22 Dati tecnici

Página
4 Notas de aviso
8 Dimensiones
10 Accesorio para el montaje
12 Tensión de alimentación
14 Transmisión de la señal
16 Estado del palpador
20 Distribución del conector
22 Características técnicas

Contents

目次
目录
目錄
목차

Page

6 Warnings
9 Dimensions
11 Mounting accessories
13 Power supply
15 Signal transmission
17 Status of the touch probe
21 Pin Layout
23 Specifications

페이지

6 注意事項
9 寸法
11 取付け用別売アクセサリ
13 電源
15 信号伝送方式
17 タッチプローブの状態
21 ピン配列
23 仕様

页

6 提示
9 尺寸
11 安裝附件
13 电源
15 信号传输
17 测头状态
21 针脚编号
23 技术参数

頁碼

6 警告
9 尺寸
11 安裝零件
13 供應電壓
15 信號傳輸
17 接觸式探針狀態
21 接腳配置
23 規格

페이지

6 경고
9 규격
11 설치용 부속품
13 전원 공급
15 신호 전송
17 터치 프로브의 상태
21 핀 레이아웃
23 사양

Warnhinweise
Warnings
Avertissement
Avvertenze
Notas de aviso



Achtung: Die Montage und Inbetriebnahme ist von einer qualifizierten Fachkraft unter Beachtung der örtlichen Sicherheitsvorschriften vorzunehmen.

Die Steckverbindung darf nur spannungsfrei verbunden oder gelöst werden.

Note: *Mounting and commissioning is to be conducted by a qualified specialist under compliance with local safety regulations.*

Do not engage or disengage any connections while under power.

Attention: le montage et la mise en service doivent être assurés par un personnel qualifié dans le respect des consignes de sécurité locales.

Le connecteur ne doit être connecté ou déconnecté qu'hors potentiel.

Attenzione: *Il montaggio e la messa in funzione devono essere eseguite da personale qualificato nel rispetto delle norme di sicurezza locali.*

I cavi posso essere collegati o scollegati solo in assenza di tensione.

Atención: El montaje y la puesta en marcha deben ser realizados por un especialista cualificado, observando las prescripciones locales de seguridad.

Conectar o desconectar el conector sólo en ausencia de tensión.

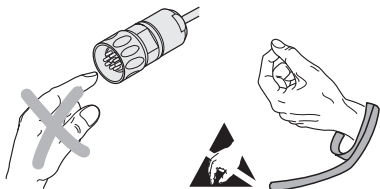

Tastsystem nicht fallen lassen.
Do not drop the touch probe.
Ne pas laisser tomber le palpeur.
Non far cadere il tastatore.
No dejar caer el palpador.

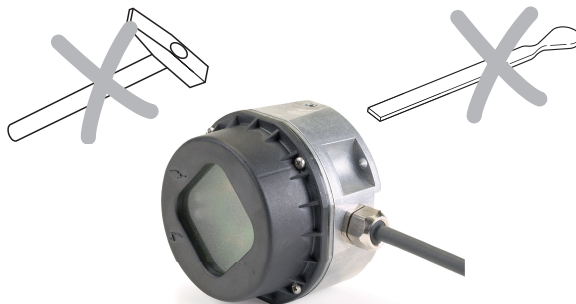

Warnings

注意事項

提示

警告

경고



Note: Mounting and commissioning is to be conducted by a qualified specialist under compliance with local safety regulations.

Do not engage or disengage any connections while under power.

注意: 取付け及び試運転は設置国の安全規格のもとで有資格の専門家により実施するようにしてください。

製品の取付けあるいは取外しは、給電されていないときに行ってください。

注意: 安装和调试时必须符合当地安全要求并由具有资质的专业人员操作。

带电时, 严禁连接或断开任何接线。

注意: 安装與調整要經由已認證的專業人員指導以符合當地安全規範要求。

當電源開啓時, 請勿連接或拔除連接電纜。

주의: 설치 및 조정은 한국의 안전도 규정에 의하여 작업을 수행할 수 있는 공인된 기술자에 의해 수행되어야 합니다.

전기가 공급된 상황에서는 절대로 연결 또는 분리를 하지 마세요.

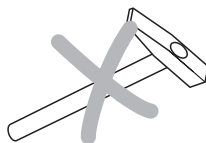
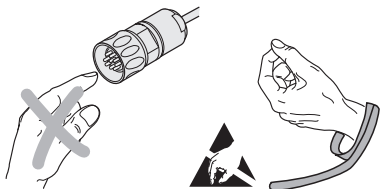

Do not drop the touch probe.

タッチプローブを落とさないでください。

请不要使测头跌落。

探針請勿掉落。

터치 프루브를 떨어뜨리면 안됩니다.



Abmessungen
Dimensions
Dimensioni
Dimensiones

mm



Tolerancing ISO 8015
 ISO 2768 - m H
 < 6 mm: ± 0.2 mm

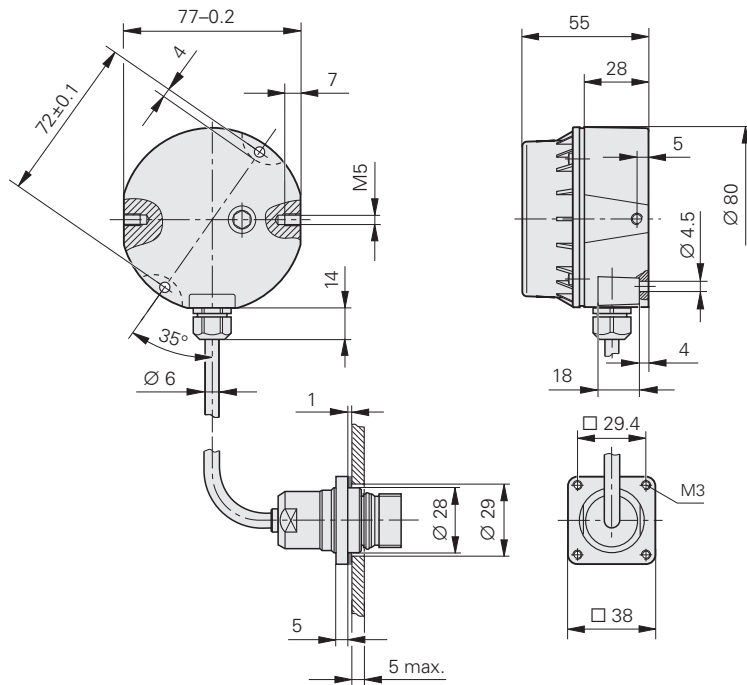

Dimensions

寸法
尺寸
尺寸
규격

mm



Tolerancing ISO 8015
ISO 2768 - m H
< 6 mm: ± 0.2 mm

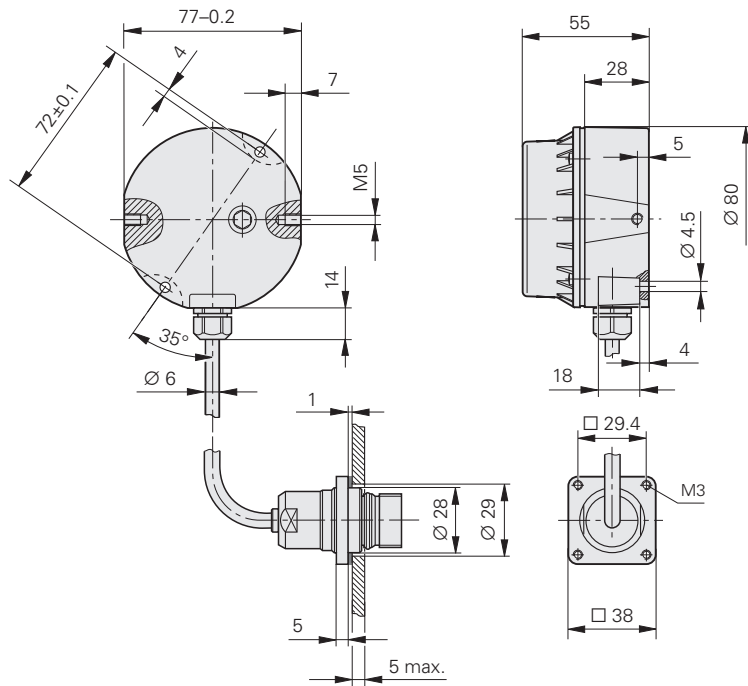

Montagezubehör
Mounting accessories
Accessoire de montage
Accessori di montaggio
Accesorio para el montaje

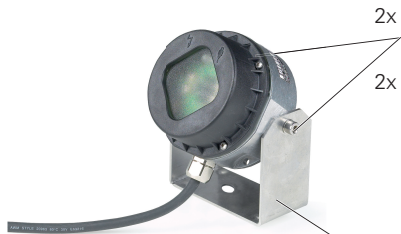

2x  ISO 4762 – M5x10
M_d = 5 Nm

2x  ISO 7089 – 5

Nicht im Lieferumfang enthalten

Not included in delivery

non compris dans la fourniture

non incluso nella fornitura

no incluido en los elementos suministrados

ID 370827-01

Separat bestellen

To be ordered separately

Commander séparément

Da ordinare separatamente

Pedir por separado

Mounting accessories

取付け用別売アクセサリ

安裝附件

安裝零件

설치용 부속품

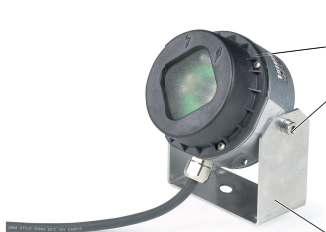

2x  ISO 4762 – M5x10

M_d = 5 Nm

2x  ISO 7089 – 5

Not included in delivery

同梱されていません

不在供货范围内

不包含出貨範圍內

납품 시 동봉하지 않음

ID 370827-01

To be ordered separately

別売品

需单独订购

須另外訂購的項目

별도로 주문하려면

Spannungsversorgung
Power supply
Tension d'alimentation
Tensione di alimentazione
Tensión de alimentación

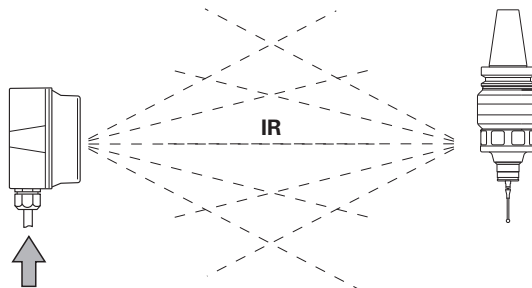

U_P: DC 15 V ... 30 V

Normalbetrieb: ≤ 170 mA

Senden (max. 3.5 s): ≤ 250 mA_{eff} (ohne Last)

Normal operation: ≤ 170 mA

Transmission (max. 3.5 s): ≤ 250 mA_{eff} (without load)

Fonctionnement normal: ≤ 170 mA

Emission (3.5 s max.): ≤ 250 mA_{eff} (sans charge)

Funzionamento normale: ≤ 170 mA

Trasmissione (max. 3.5 s): ≤ 250 mA_{eff} (in assenza di carico)

Funcionamiento normal: ≤ 170 mA

Emitir (máx. 3.5 s): ≤ 250 mA_{eff} (sin carga)

Power supply

電源

电源

供應電壓

전원 공급

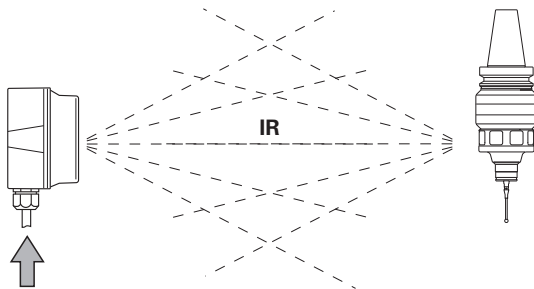

U_p: DC 15V ... 30V

Normal operation: ≤ 170 mA

Transmission (max. 3.5 s): ≤ 250 mA_{eff} (without load)

通常動作時: ≤ 170 mA

伝送時 (最大3.5秒): ≤ 250 mA_{eff} (負荷なし)

正常工作: ≤ 170 mA

传输 (最大3.5 s): ≤ 250 mA_{eff} (空载)

正常操作: ≤ 170 mA

傳輸 (max. 3.5 s): ≤ 250 mA_{eff} (無負載)

공칭 작업: ≤ 170 mA

전송(최대 3.5초): ≤ 250 mA_{eff}(부하 제외)

Signalübertragung
Signal transmission
Transmission du signal
Trasmissione del segnale
Transmisión de la señal

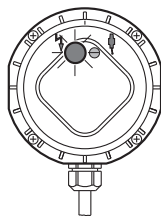
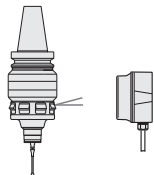

<p>● grün <i>green</i> vert verde verde</p>	<p>in Ordnung <i>Proper function</i> correct <i>corretto</i> correcto</p>
<p>● gelb <i>yellow</i> jaune <i>giallo</i> amarillo</p>	<p>noch akzeptabel <i>Acceptable function</i> encore acceptable <i>accettabile</i> aún acceptable</p>
<p>● rot <i>red</i> rouge rosso rojo</p>	<p>nicht akzeptabel <i>Not acceptable function</i> non acceptable <i>non accettabile</i> no acceptable</p>

Signal transmission

信号伝送方式

信号传输

信號傳輸

신호 전송

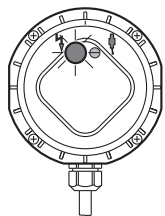
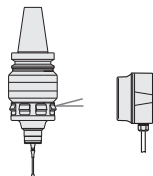

<p>● green 緑 绿色 綠色 녹색</p>	<p>Proper function 正常 正常工作 符合功能 정상 작동</p>
<p>● yellow 黄 黄色 黃色 황색</p>	<p>Acceptable function 使用可能 可接受工作 可接受功能 허용 가능한 기능</p>
<p>● red 赤 红色 紅色 적색</p>	<p>Not acceptable function 使用不可能 不可接受工作 無法接受的功能 허용 불가능한 기능</p>

Zustand des Tastsystem
Status of the touch probe
Etat du palpeur
Stato del sistema di tastatura
Estado del palpador

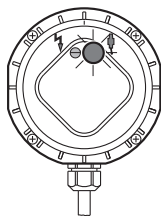
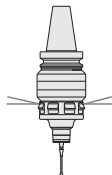

<p>● grün <i>green</i> vert verde verde</p>	<p>Tastsystem bereit, Taststift in Ruhelage <i>Touch probe ready, stylus at position of rest</i> Palpeur prêt, tige de palpation au repos <i>Sistema di tastatura pronto, stilo a riposo</i> Palpador preparado, vástago en posición de reposo</p>
<p>● gelb <i>yellow</i> jaune giallo amarillo</p>	<p>Tastsystem bereit, Taststift ausgelenkt <i>Touch probe ready, stylus deflected</i> Palpeur prêt, tige de palpation déviée <i>Sistema di tastatura pronto, stilo deflesso</i> Palpador preparado, vástago inclinado</p>
<p>● rot <i>red</i> rouge rosso rojo</p>	<p>Batteriewarnung, Batterie wechseln <i>Battery warning, change the battery</i> Alerte de pile, changer de pile <i>Allarme batteria, cambiare batteria</i> Aviso de batería, cambiar batería</p>
<p>○</p>	<p>Tastsystem nicht bereit <i>Touch probe not ready</i> Palpeur non prêt <i>Sistema di tastatura non pronto</i> Palpador no preparado</p>

Status of the touch probe

タッチプローブの状態

测头状态

接觸式探針狀態

터치 프로브의 상태

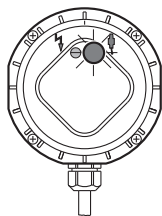
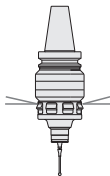

<ul style="list-style-type: none">● green 緑 绿色 綠色 녹색	<p>Touch probe ready, stylus at position of rest タッチプローブ使用可能、スタイラスはフリーの状態 测头就绪，测针在自由位置 接觸式探針備妥，探針於復歸位置 터치 프로브 준비, 스타일러스 정지 위치</p>
<ul style="list-style-type: none">● yellow 黄 黄色 黃色 황색	<p>Touch probe ready, stylus deflected タッチプローブ使用可能、スタイラスはワークを検知 测头就绪，测针偏离自由位置 接觸式探針備妥，探針已偏移 터치 프로브 준비, 스타일러스 굴절됨</p>
<ul style="list-style-type: none">● red 赤 红色 紅色 적색	<p>Battery warning, change the battery バッテリー警告、バッテリー交換が必要 电池报警，换电池 電池警告，更換新電池 배터리 경고, 배터리 교환</p>
<ul style="list-style-type: none">○	<p>Touch probe not ready タッチプローブ使用不可能 测头未就绪 接觸式探針未備妥 터치 프로브 준비 안 됨</p>

TS 440
TS 640

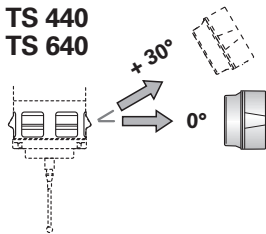

Rundumabstrahlung
360°-range transmission
Transmission sur 360°
Irradiazione a 360°
Radiación perimetral

Übertragungsbereich
Transmission area
Plage de transmission
Campo di trasmissione
Rango de transmisión

■ **TS 440**
■ **TS 640**

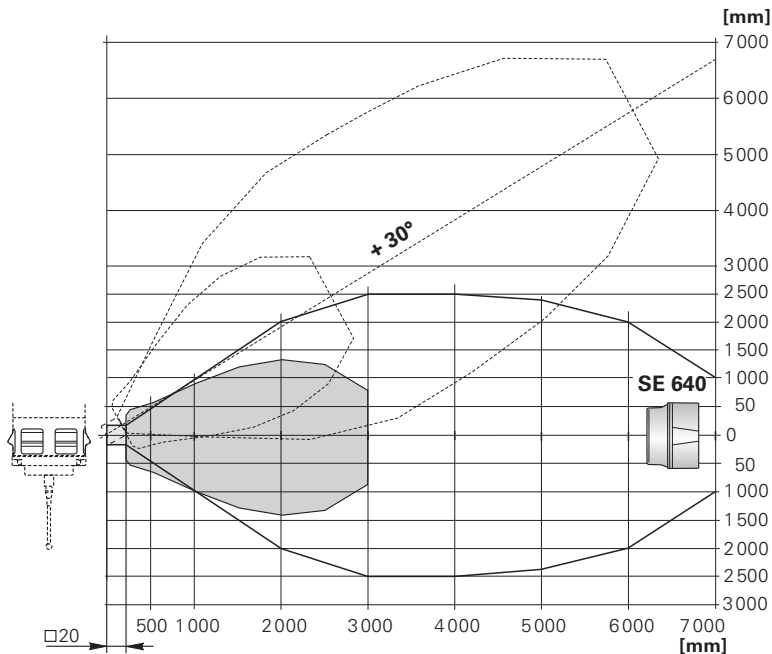

TS 440
TS 640

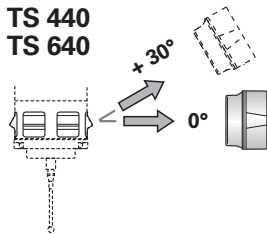

360°-range transmission
 伝送範囲 360°
 360° 传输范围
 360° - 傳輸範圍
 360° 범위 전송

Transmission area
 伝送範囲
 传输范围
 傳輸區域
 전송 영역

■ **TS 440**
 ■ **TS 640**

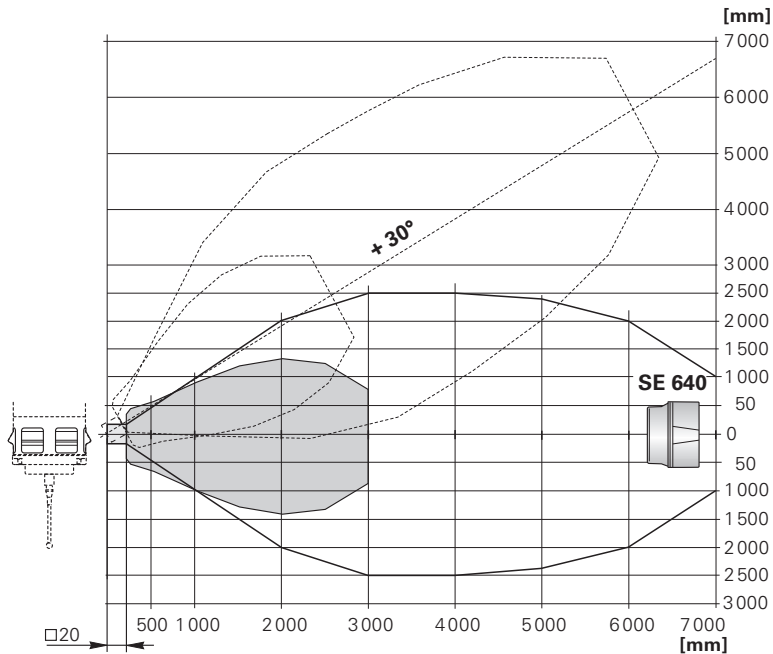

Anschlussbelegung





Pin Layout

Raccordements

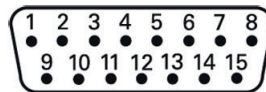
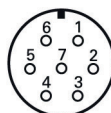
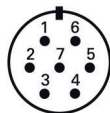
Piedinatura

Distribución del conector



 	2	1	7	3	5	4	6
	5	8	1	4	3	10	7
	Up	0V	*)	R	B	S	W
	BN	WH	WHBN	YE	GY	GN	BU

***)** = Innenschirm
Internal shield
 Blindage interne
Schermo interno
 Blindaje interno

R = Startsignal
Start signal
 Signal départ
Segnale di accensione
 Señal de arranque

Nichtverwendete Pins oder Litzen dürfen nicht belegt werden!
Vacant pins or wires must not be used!
 Les plots ou fils non utilisés ne doivent pas être raccordés!
I pin o i fili inutilizzati non devono essere occupati!
 ¡No conectar los pins o hilos no utilizados!

W = Batteriewarnung
Battery warning
 Alerte de pile
Allarme batteria scarica
 Aviso de batería

B = Bereitschaft
Ready signal
 En service
Segnale di pronto
 Preparación

S = Schaltsignal
Trigger signal
 Signal de commutation
Segnale di commutazione
 Señal de conmutación

Außenschirm auf Gehäuse
External shield on housing
 Blindage externe sur boîtier
Schermo esterno sulla carcassa
 Blindaje externo a carcasa

Pin Layout

ピン配列
针脚编号
接脚配置
핀 레이아웃

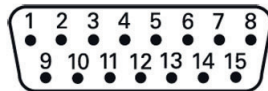

		2	1	7	3	5	4	6
		5	8	1	4	3	10	7
		Up	0V	*)	R	B	S	W
		BN	WH	WHBN	YE	GY	GN	BU

***)** = Internal shield
内部シールド
内屏蔽
内部隔離
내부 실드

R = Start signal
スタート信号
开始信号
開始信號
시작 신호

Vacant pins or wires must not be used!
未使用のピンまたは線は使用しない事!
禁止使用空针脚或空线!
空接脚或電線不得使用!
비어 있는 핀이나 와이어는 사용하지 마십시오.

W = Battery warning
バッテリー警告
電池报警
電池警告
배터리 경고

B = Ready signal
レディ信号
就绪信号
備妥信號
준비 신호

S = Trigger signal
トリガー信号
触发信号
觸發信號
트리거 신호

External shield on housing
ハウジング上の外部シールド
外壳屏蔽
外部隔離位於外殼上
하우징의 외부 실드

Technische Kennwerte
Specifications
Caractéristiques techniques
Dati tecnici
Características técnicas

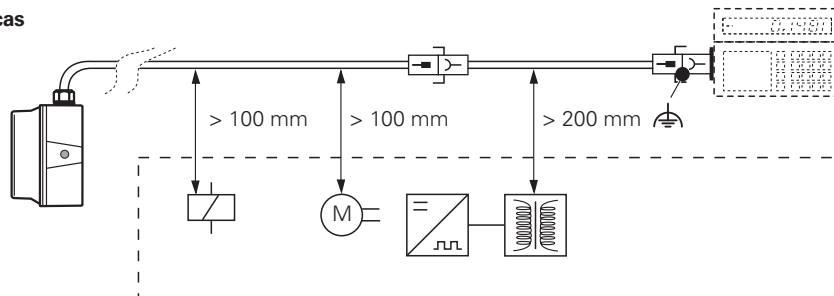

Biegeradius **R**
 Bending radius **R**
 Rayon de courbure **R**
 Piegatura **R**
 Radio de curvatura **R**

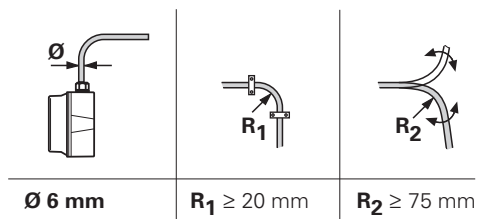

Specifications

仕様
 技术参数
 規格
 사양

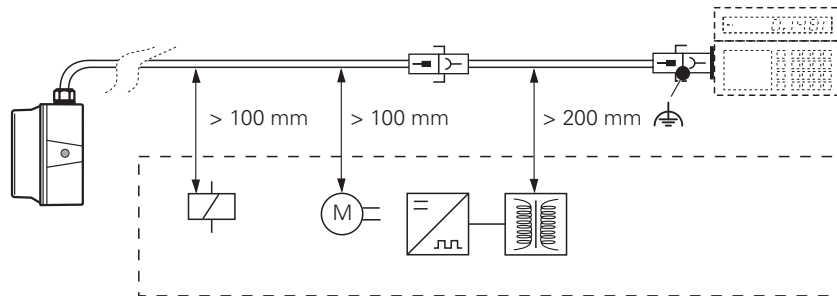

Bending radius **R**

曲げ半径 **R**

弯曲半径 **R**

彎曲半徑 **R**

구부림 반경 **R**

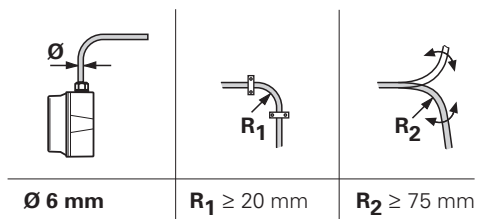

HEIDENHAIN

DR. JOHANNES HEIDENHAIN GmbH

Dr.-Johannes-Heidenhain-Straße 5

83301 Traunreut, Germany

☎ +49 8669 31-0

FAX +49 8669 5061

E-mail: info@heidenhain.de

Technical support FAX +49 8669 32-1000

Measuring systems ☎ +49 8669 31-3104

E-mail: service.ms-support@heidenhain.de

TNC support ☎ +49 8669 31-3101

E-mail: service.nc-support@heidenhain.de

NC programming ☎ +49 8669 31-3103

E-mail: service.nc-pgm@heidenhain.de

PLC programming ☎ +49 8669 31-3102

E-mail: service.plc@heidenhain.de

Lathe controls ☎ +49 8669 31-3105

E-mail: service.lathe-support@heidenhain.de

www.heidenhain.de

